

MPM pump

Features and Strengths

Highly operational reliability despite fluctuating or low compressed-air pressure
Extremely low noise level
Available with a three-stage MIDI vacuum cartridge pump integrate
Up to 16 cartridges with high vacuum flow

Advantages

Large vacuum flow to replace 4kw (5Hp) electric motor pump
Reliable and stable operation - High vacuum level and vacuum flow in efficient air consumption
Durable and light aluminum body

| Application

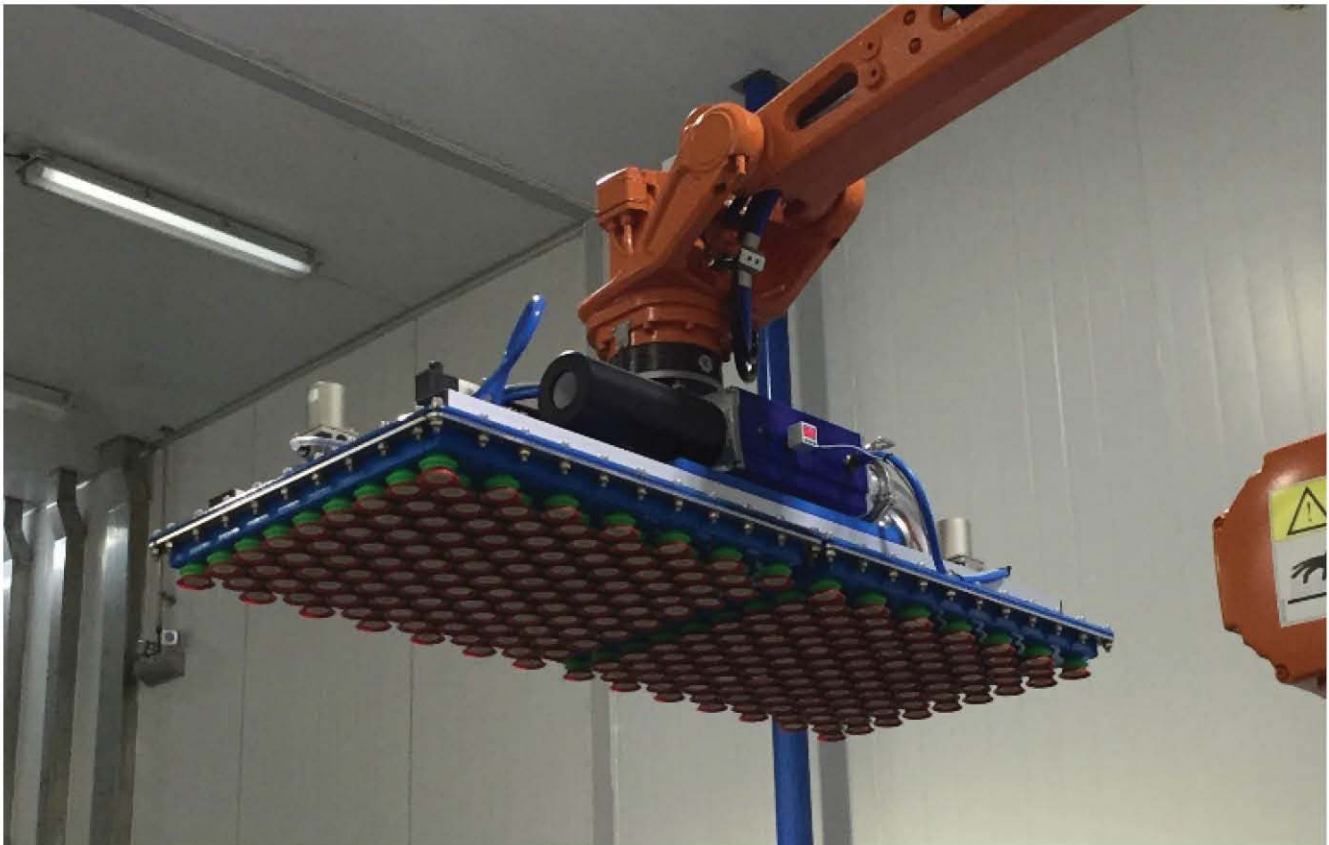



Overall of specification

Model	Max. Vacuum level (- kPa)	Max. Feed Pressure (bar)	Max. Vacuum Flow (NI/m)	Air Consumption (NI/m)	Noise level (dBA)
MPM303x6	92	7	2046	804	55 ~ 62
MPM303x8	92	7	2728	1072	55 ~ 62
MPM303x10	92	7	3410	1340	55 ~ 62
MPM303x12	92	7	4092	1608	55 ~ 62
MPM303x14	92	7	4774	1876	55 ~ 62
MPM303x16	92	7	5456	2144	55 ~ 62
MPML303x6	75	7	2172	624	55 ~ 62
MPML303x8	75	7	2896	832	55 ~ 62
MPML303x10	75	7	3620	1040	55 ~ 62
MPML303x12	75	7	4344	1248	55 ~ 62
MPML303x14	75	7	5068	1456	55 ~ 62
MPML303x16	75	7	5792	1664	55 ~ 62

VACUUM PUMPS / Mega Premium pumps

MPM pump

VMECA MPM pump can be combined with the optional Vacuum On/Off control valve, vacuum release valve and vacuum switch to create an optimal vacuum solution especially for high vacuum flow – Maximum 16 cartridges. It can replace up to 4kw motor pumps with many better advantages such performance, size, weight, noise level and etc. Also it can contribute dramatic energy saving effect by VMECA air saving kit.



Key advantages

- VMECA vacuum cartridge integrated
- High vacuum flow as much as replaced with 4kw motor pump
- Quite low noise level

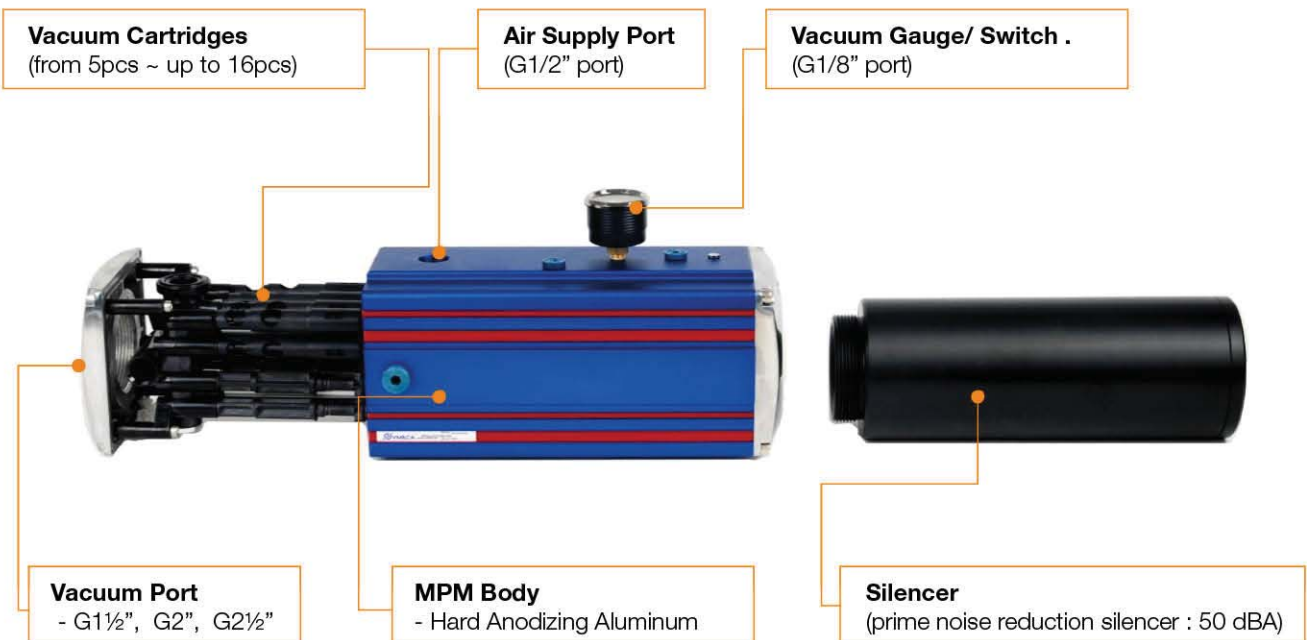

Comparison against motor pump

- Compact size & Lighter weight
- Fast maintenance & Low sound level
- No heat emission



Size	Huge	Compact
Weight	Much heavy	Light
Heat emission	Max. 40°C	None
Vacuum flow	High vacuum flow	High vacuum flow
Noise level	High noise level	Low noise level

※ Comparison data above can be different according to motor pump model.

MPM pump with ASV kit (Air Saving Kit + Air Control Valve)



VMECA's ASV Kit (Air Saving Kit + Air control valve) is the most effective way to save the energy (compressed air) in a pneumatic control system which can cut off the vacuum pump once the desired vacuum has been achieved thus minimized compressed air is only consumed.
(See page : 603)

VACUUM PUMPS / Mega Premium pumps

MPM303x6 / MPML303x6

Features and Strengths

- Highly operational reliability despite fluctuating or low compressed-air pressure
- High vacuum flow with low energy consumption
 - Available to replace 4kw(5Hp) electric motor pump
- Very low noise level
- Durable and light aluminum body



Specifications

Description	MPM303x6	MPML303x6
Max. Vacuum level	-92 kPa	-75 kPa
Open Vacuum flow	2046 NI/min	2172NI/min
Max. Feed pressure	7 bar	7 bar
Temperature	-20 ~ 80 °C	-20 ~ 80 °C
Noise level	55 ~ 62 dbA	55 ~ 62 dbA
Weight	4,491 g	4,487 g

Vacuum Flow

Model	Max. vacuum (-kPa)	Feed Pressure (bar)	Vacuum flow (NI/min) at different vacuum levels (-kPa)									
			0	10	20	30	40	50	60	70	80	90
MPM303x6	75	2.2	1812	735	528	318	188.4	171	99	27.6	-	-
	92	3.0	2028	912	636	384	198	192	132	99	38.4	11.4
	92	4.0	2046	924	765	564	414	258	139.8	103.8	41.4	12.6
MPML303x6	60	4.0	1812	1056	660	420	276	168	40.8	-	-	-
	70	5.0	2064	1200	780	492	300	225	138	71.4	-	-
	75	6.0	2172	1164	924	600	312	228	192	132	-	-

Evacuation Time

Model	Feed Pressure (bar)	Air Consumption (NI/min)	Evacuation time in sec / liter to reach different vacuum levels (-kPa)									
			10	20	30	40	50	60	70	80	90	
MPM303x6	2.2	588	0.0038	0.013	0.0483	0.055	0.08	0.128	0.28	-	-	-
	3.0	672	0.0032	0.0098	0.0217	0.0433	0.0733	0.115	0.162	0.263	0.642	-
	4.0	804	0.003	0.0088	0.0133	0.025	0.0433	0.093	0.143	0.26	0.63	-
MPML303x6	4.0	420	0.0047	0.015	0.0283	0.0483	0.0633	0.1333	-	-	-	-
	5.0	510	0.0022	0.0133	0.025	0.0417	0.05	0.0667	0.1333	-	-	-
	6.0	624	0.002	0.0117	0.02	0.0333	0.0467	0.0600	0.1	-	-	-

MPM303x8 / MPML303x8

Features and Strengths

- Highly operational reliability despite fluctuating or low compressed-air pressure
- High vacuum flow with low energy consumption
 - Available to replace 4kw(5Hp) electric motor pump
- Very low noise level
- Durable and light aluminum body



Specifications

Description	MPM303x8	MPML303x8
Max. Vacuum level	-92 kPa	-75 kPa
Open Vacuum flow	2728 NI/min	2896 NI/min
Max. Feed pressure	7 bar	7 bar
Temperature	-20 ~ 80 °C	-20 ~ 80 °C
Noise level	55 ~ 62 dbA	55 ~ 62 dbA
Weight	4,483 g	4,478 g

Vacuum Flow

Model	Max. vacuum (-kPa)	Feed Pressure (bar)	Vacuum flow (NI/min) at different vacuum levels (-kPa)									
			0	10	20	30	40	50	60	70	80	90
MPM303x8	75	2.2	2416	980	704	424	251.2	228	132	36.8	-	-
	92	3.0	2704	1216	848	512	264	256	176	132	51.2	15.2
	92	4.0	2728	1232	1020	752	552	344	186.4	138.4	55.2	16.8
MPML303x8	60	4.0	2416	1408	880	560	368	224	54.4	-	-	-
	70	5.0	2752	1600	1040	656	400	300	184	95.2	-	-
	75	6.0	2896	1552	1232	800	416	304	256	176	-	-

Evacuation Time

Model	Feed Pressure (bar)	Air Consumption (NI/min)	Evacuation time in sec / liter to reach different vacuum levels (-kPa)									
			10	20	30	40	50	60	70	80	90	
MPM303x8	2.2	784	0.0029	0.0098	0.0363	0.0413	0.06	0.096	0.21	-	-	-
	3.0	896	0.0024	0.0074	0.0163	0.0325	0.055	0.086	0.121	0.1975	0.481	-
	4.0	1072	0.0023	0.0066	0.01	0.0188	0.0325	0.07	0.1075	0.195	0.473	-
MPML303x8	4.0	560	0.0035	0.0113	0.0213	0.0363	0.0475	0.1	-	-	-	-
	5.0	680	0.0016	0.01	0.0188	0.0313	0.0375	0.05	0.1	-	-	-
	6.0	832	0.0015	0.0088	0.0150	0.0250	0.0350	0.0450	0.075	-	-	-

VACUUM PUMPS / Mega Premium pumps

MPM303x10 / MPML303x10

Features and Strengths

- Highly operational reliability despite fluctuating or low compressed-air pressure
- High vacuum flow with low energy consumption
 - Available to replace 4kw(5Hp) electric motor pump
- Very low noise level
- Durable and light aluminum body



Specifications

Description	MPM303x10	MPML303x10
Max. Vacuum level	-92 kPa	-75 kPa
Open Vacuum flow	3410 NI/min	3620 NI/min
Max. Feed pressure	7 bar	7 bar
Temperature	-20 ~ 80 °C	-20 ~ 80 °C
Noise level	55 ~ 62 dbA	55 ~ 62 dbA
Weight	4,476 g	4,469 g

Vacuum Flow

Model	Max. vacuum (-kPa)	Feed Pressure (bar)	Vacuum flow (NI/min) at different vacuum levels (-kPa)									
			0	10	20	30	40	50	60	70	80	90
MPM303x10	75	2.2	3020	1225	880	530	314	285	165	46		
	92	3.0	3380	1520	1060	640	330	320	220	165	64	19
	92	4.0	3410	1540	1275	940	690	430	233	173	69	21
MPML303x10	60	4.0	3020	1760	1100	700	460	280	68		-	-
	70	5.0	3440	2000	1300	820	500	375	230	119	-	-
	75	6.0	3620	1940	1540	1000	520	380	320	220	-	-

Evacuation Time

Model	Feed Pressure (bar)	Air Consumption (NI/min)	Evacuation time in sec / liter to reach different vacuum levels (-kPa)									
			10	20	30	40	50	60	70	80	90	
MPM303x10	2.2	980	0.0023	0.0078	0.029	0.033	0.048	0.077	0.168	-	-	
	3.0	1120	0.0019	0.0059	0.013	0.026	0.044	0.069	0.097	0.158	0.385	
	4.0	1340	0.0018	0.0053	0.008	0.015	0.026	0.056	0.086	0.156	0.378	
MPML303x10	4.0	700	0.0028	0.009	0.017	0.0290	0.038	0.08	-	-	-	
	5.0	850	0.0013	0.008	0.015	0.025	0.03	0.04	0.08	-	-	
	6.0	1040	0.0012	0.007	0.012	0.02	0.028	0.036	0.06	-	-	

MPM303x12 / MPML303x12

Features and Strengths

- Highly operational reliability despite fluctuating or low compressed-air pressure
- High vacuum flow with low energy consumption
 - Available to replace 4kw(5Hp) electric motor pump
- Very low noise level
- Durable and light aluminum body



Specifications

Description	MPM303x12	MPML303x12
Max. Vacuum level	-92 kPa	-75 kPa
Open Vacuum flow	4092 NI/min	4344 NI/min
Max. Feed pressure	7 bar	7 bar
Temperature	-20 ~ 80 °C	-20 ~ 80 °C
Noise level	55 ~ 62 dbA	55 ~ 62 dbA
Weight	4,469 g	4,460 g

Vacuum Flow

Model	Max. vacuum (-kPa)	Feed Pressure (bar)	Vacuum flow (NI/min) at different vacuum levels (-kPa)									
			0	10	20	30	40	50	60	70	80	90
MPM303x12	75	2.2	3624	1470	1056	636	376.8	342	198	55.2	-	-
	92	3.0	4056	1824	1272	768	396	384	264	198	76.8	22.8
	92	4.0	4092	1848	1530	1128	828	516	279.6	207.6	82.8	25.2
MPML303x12	60	4.0	3624	2112	1320	840	552	336	81.6	-	-	-
	70	5.0	4128	2400	1560	984	600	450	276	142.8	-	-
	75	6.0	4344	2328	1848	1200	624	456	384	264	-	-

Evacuation Time

Model	Feed Pressure (bar)	Air Consumption (NI/min)	Evacuation time in sec / liter to reach different vacuum levels (-kPa)									
			10	20	30	40	50	60	70	80	90	
MPM303x12	2.2	1176	0.0019	0.0065	0.0242	0.0275	0.04	0.064	0.14	-	-	-
	3.0	1344	0.0016	0.0049	0.0108	0.0217	0.0367	0.0575	0.081	0.132	0.321	-
	4.0	1608	0.0015	0.0044	0.0067	0.0125	0.0217	0.047	0.072	0.13	0.315	-
MPML303x12	4.0	840	0.0023	0.0075	0.0142	0.0242	0.0317	0.0667	-	-	-	-
	5.0	1020	0.0011	0.0067	0.0125	0.0208	0.025	0.0333	0.0667	-	-	-
	6.0	1248	0.001	0.0058	0.01	0.0167	0.0233	0.03	0.05	-	-	-

VACUUM PUMPS / Mega Premium pumps

MPM303x14 / MPML303x14

Features and Strengths

- Highly operational reliability despite fluctuating or low compressed-air pressure
- High vacuum flow with low energy consumption
 - Available to replace 4kw(5Hp) electric motor pump
- Very low noise level
- Durable and light aluminum body



Specifications

Description	MPM303x14	MPML303x14
Max. Vacuum level	-92 kPa	-75 kPa
Open Vacuum flow	4774 NI/min	5068 NI/min
Max. Feed pressure	7 bar	7 bar
Temperature	-20 ~ 80 °C	-20 ~ 80 °C
Noise level	55 ~ 62 dbA	55 ~ 62 dbA
Weight	4,461 g	4,451 g

Vacuum Flow

Model	Max. vacuum (-kPa)	Feed Pressure (bar)	Vacuum flow (NI/min) at different vacuum levels (-kPa)									
			0	10	20	30	40	50	60	70	80	90
MPM303x14	75	2.2	4228	1715	1232	742	439.6	399	231	64.4	-	-
	92	3.0	4732	2128	1484	896	462	448	308	231	89.6	26.6
	92	4.0	4774	2156	1785	1316	966	602	326.2	242.2	96.6	29.4
MPML303x14	60	4.0	4228	2464	1540	980	644	392	95.2	-	-	-
	70	5.0	4816	2800	1820	1148	700	525	322	166.6	-	-
	75	6.0	5068	2716	2156	1400	728	532	448	308	-	-

Evacuation Time

Model	Feed Pressure (bar)	Air Consumption (NI/min)	Evacuation time in sec / liter to reach different vacuum levels (-kPa)								
			10	20	30	40	50	60	70	80	90
MPM303x14	2.2	1372	0.0016	0.0056	0.0207	0.0236	0.0343	0.055	0.12	-	-
	3.0	1568	0.0014	0.0042	0.0093	0.0186	0.0314	0.0493	0.0693	0.1129	0.275
	4.0	1876	0.0013	0.0038	0.0057	0.0107	0.0186	0.04	0.0614	0.1114	0.27
MPML303x14	4.0	980	0.0020	0.0064	0.0121	0.0207	0.0271	0.0571	-	-	-
	5.0	1190	0.0009	0.0057	0.0107	0.0179	0.0214	0.0286	0.0571	-	-
	6.0	1456	0.0009	0.005	0.0086	0.0143	0.0200	0.0257	0.0429	-	-

MPM303x16 / MPML303x16

Features and Strengths

- Highly operational reliability despite fluctuating or low compressed-air pressure
- High vacuum flow with low energy consumption
 - Available to replace 4kw(5Hp) electric motor pump
- Very low noise level
- Durable and light aluminum body



Specifications

Description	MPM303x16	MPML303x16
Max. Vacuum level	-92 kPa	-75 kPa
Open Vacuum flow	5456 NI/min	5792 NI/min
Max. Feed pressure	7 bar	7 bar
Temperature	-20 ~ 80 °C	-20 ~ 80 °C
Noise level	55 ~ 62 dbA	55 ~ 62 dbA
Weight	4,454 g	4,422 g

Vacuum Flow

Model	Max. vacuum (-kPa)	Feed Pressure (bar)	Vacuum flow (NI/min) at different vacuum levels (-kPa)									
			0	10	20	30	40	50	60	70	80	90
MPM303x16	75	2.2	4832	1960	1408	848	502.4	456	264	73.6	-	-
	92	3.0	5408	2432	1696	1024	528	512	352	264	102.4	30.4
	92	4.0	5456	2464	2040	1504	1104	688	372.8	276.8	110.4	33.6
MPML303x16	60	4.0	4832	2816	1760	1120	736	448	108.8	-	-	-
	70	5.0	5504	3200	2080	1312	800	600	368	190.4	-	-
	75	6.0	5792	3104	2464	1600	832	608	512	352	-	-

Evacuation Time

Model	Feed Pressure (bar)	Air Consumption (NI/min)	Evacuation time in sec / liter to reach different vacuum levels (-kPa)									
			10	20	30	40	50	60	70	80	90	
MPM303x16	2.2	1568	0.0014	0.0049	0.0181	0.0206	0.03	0.048	0.105	-	-	-
	3.0	1792	0.0012	0.0037	0.0081	0.0163	0.0275	0.0431	0.0606	0.0988	0.2406	-
	4.0	2144	0.0011	0.0033	0.005	0.0094	0.0163	0.035	0.0538	0.0975	0.2363	-
MPML303x16	4.0	1120	0.0018	0.0056	0.0106	0.0181	0.0238	0.05	-	-	-	-
	5.0	1360	0.0008	0.005	0.0094	0.0156	0.0188	0.025	0.05	-	-	-
	6.0	1664	0.0008	0.0044	0.0075	0.0125	0.0175	0.0225	0.0375	-	-	-

VACUUM PUMPS / Mega Premium pumps

I Dimensions – MPM303 / MPML303

[Unit : mm]

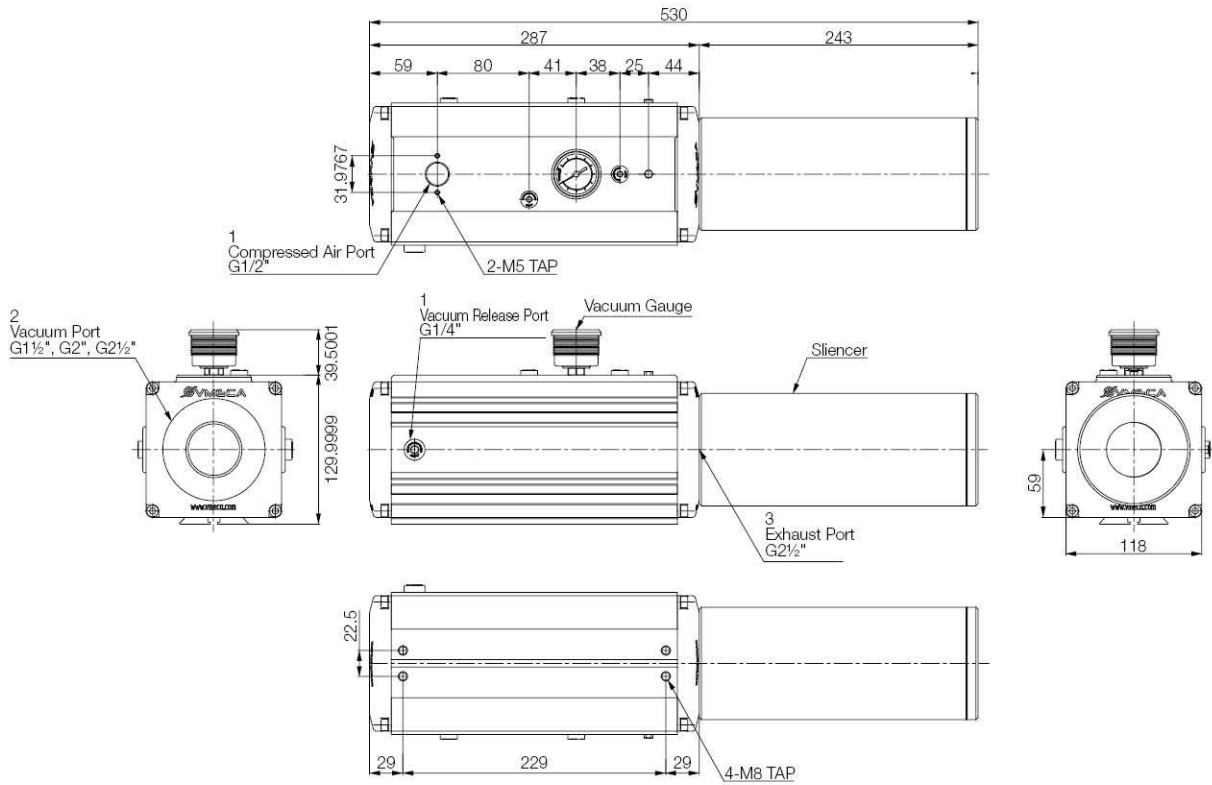

I Dimensions – with Accessories

[Unit : mm]

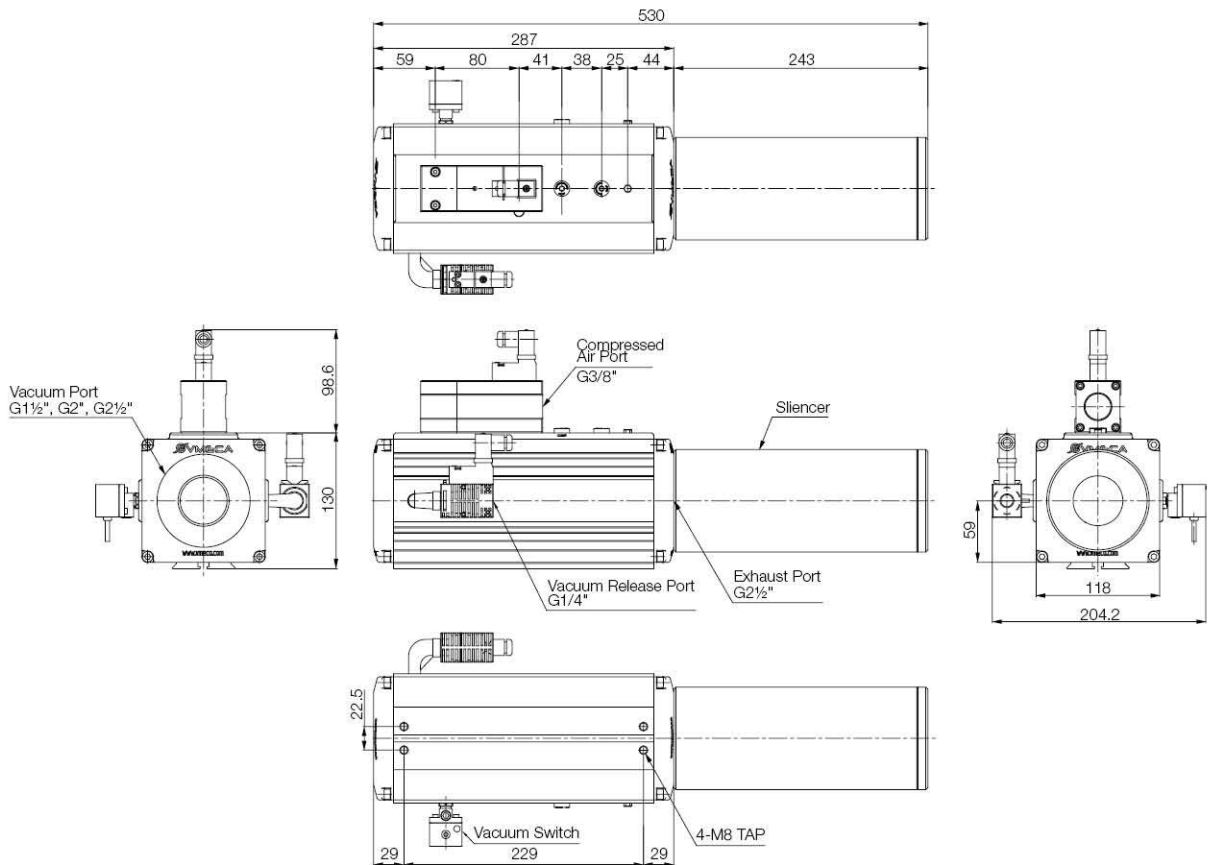

Performance data

MPM303x6

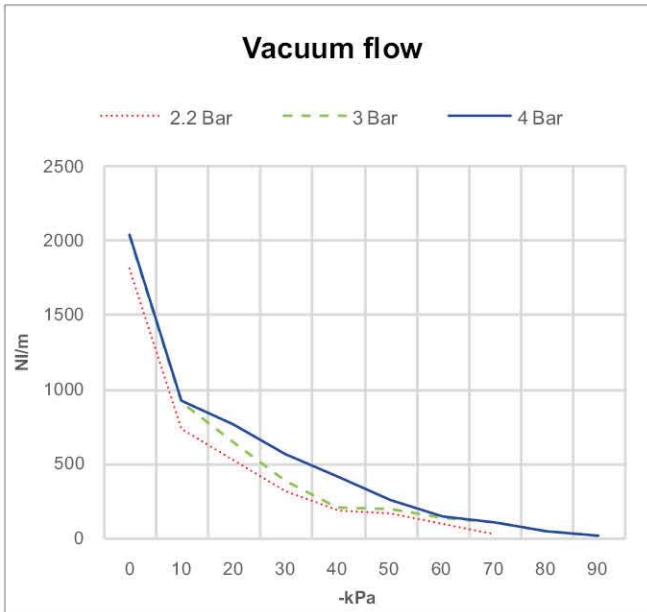

※ Vacuum flow at different vacuum level

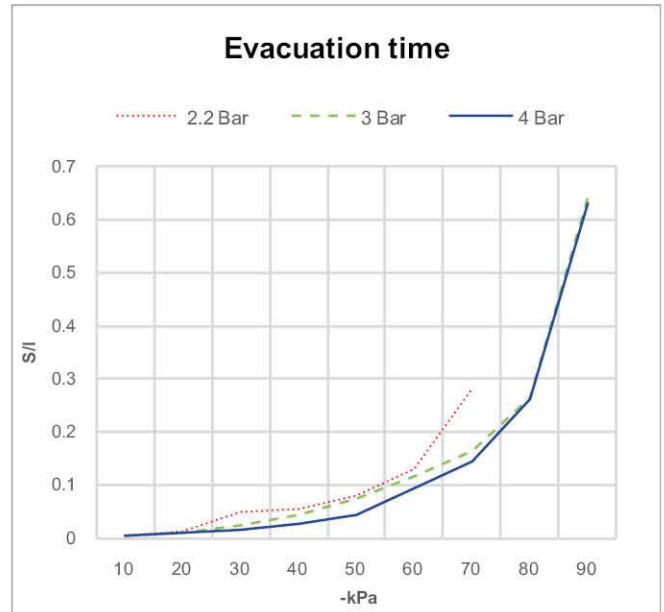

※ Time to evacuate a volume at different vacuum level

MPML303x6

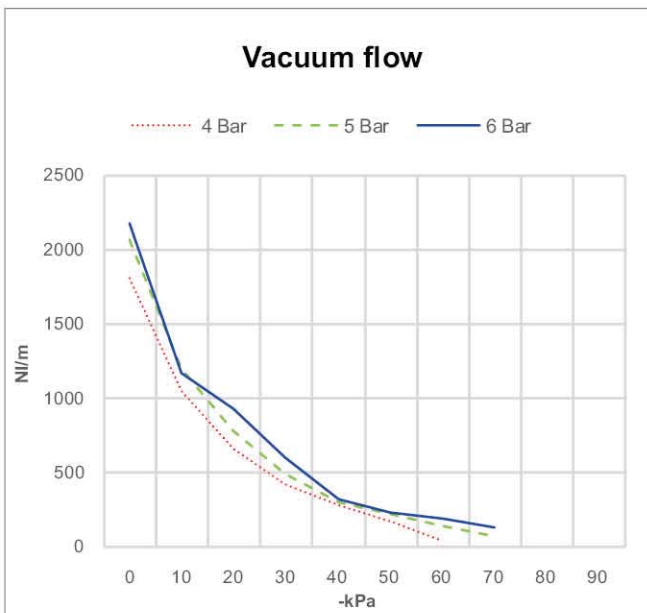

※ Vacuum flow at different vacuum level

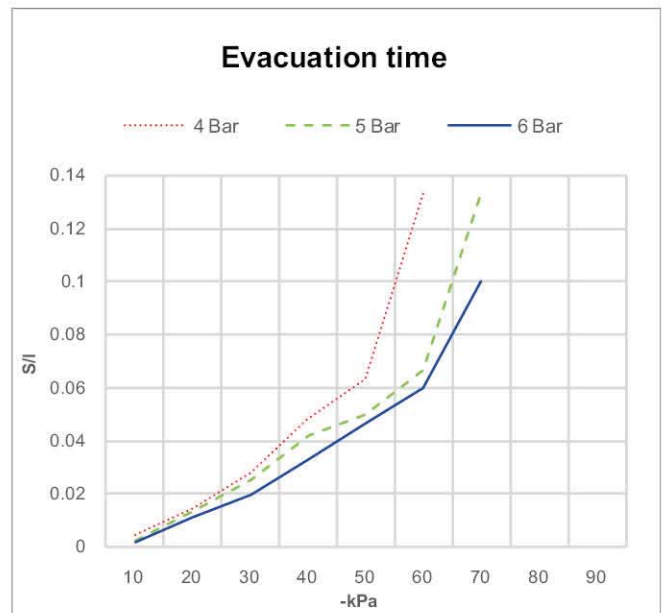

※ Time to evacuate a volume at different vacuum level

VACUUM PUMPS / Mega Premium pumps

Performance data

MPM303x8

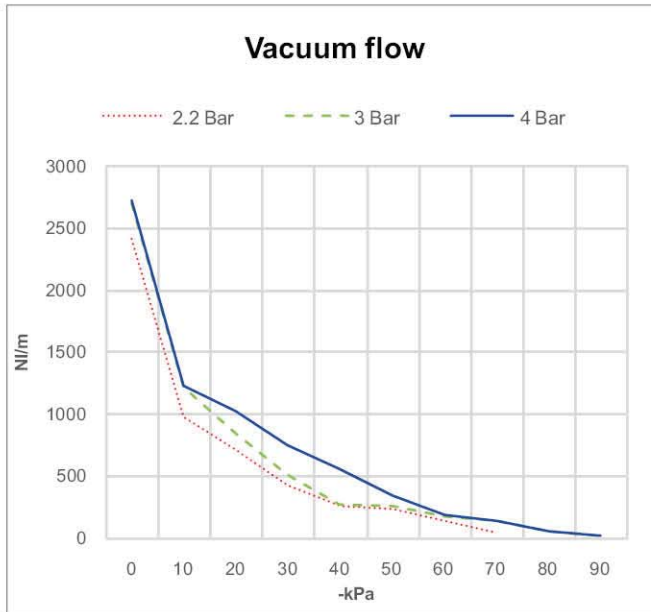

※ Vacuum flow at different vacuum level

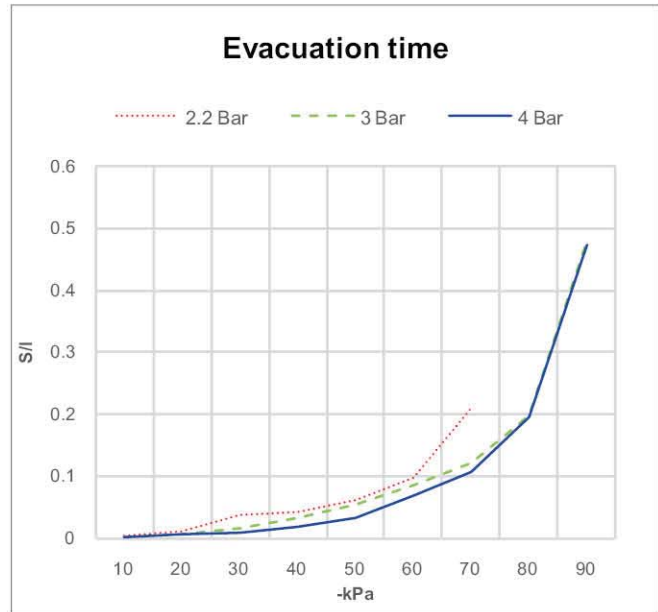

※ Time to evacuate a volume at different vacuum level

MPML303x8

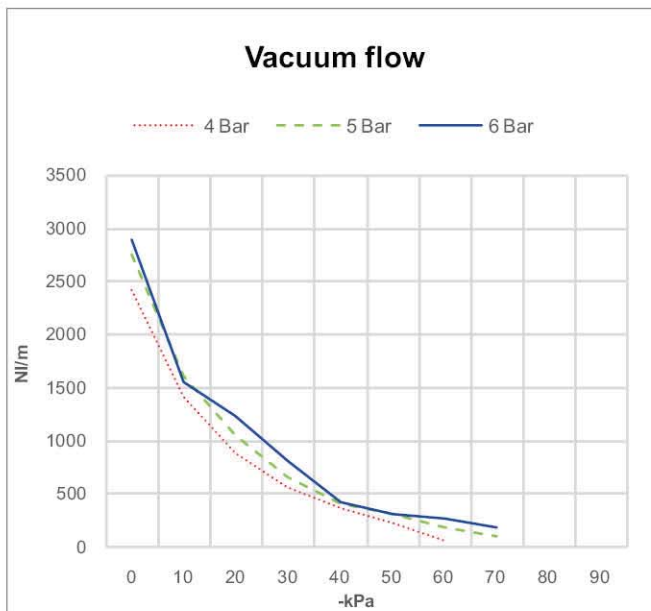

※ Vacuum flow at different vacuum level

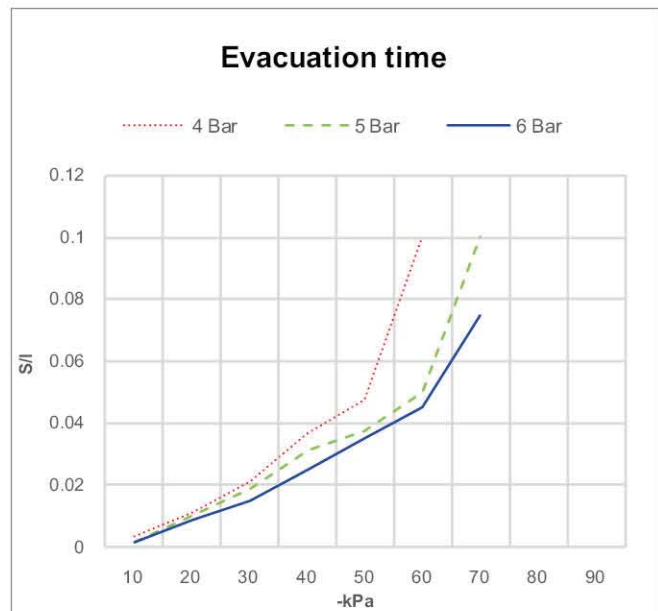

※ Time to evacuate a volume at different vacuum level

Performance data

MPM303x10

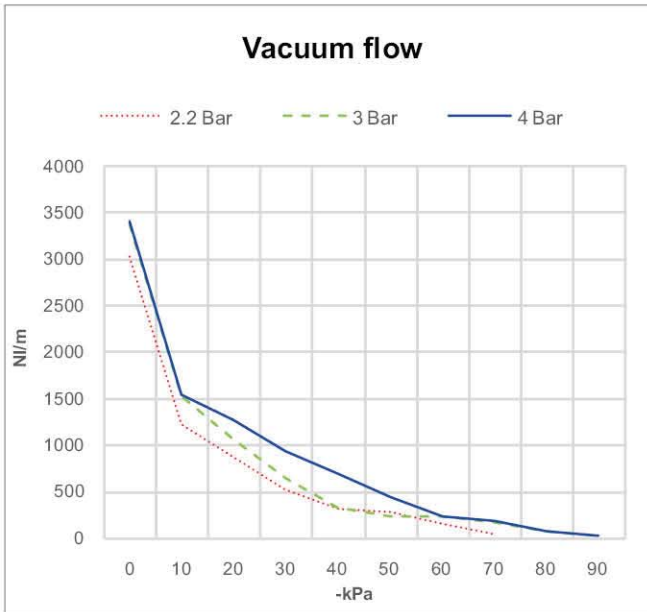

※ Vacuum flow at different vacuum level

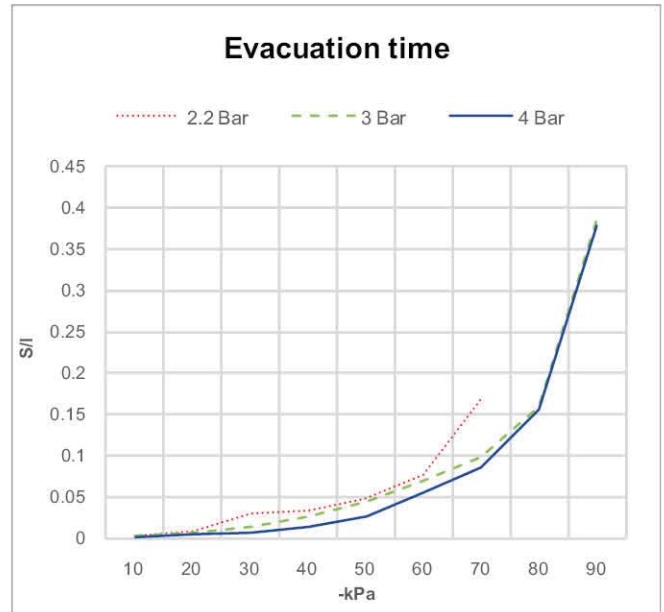

※ Time to evacuate a volume at different vacuum level

MPML303x10

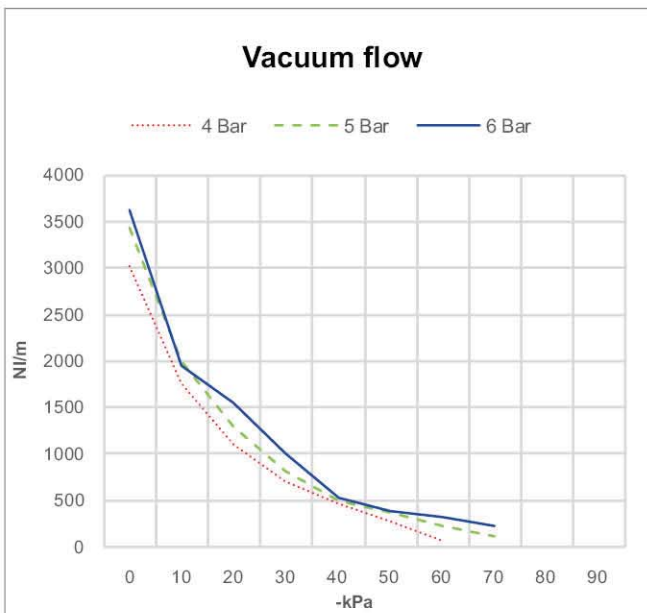

※ Vacuum flow at different vacuum level

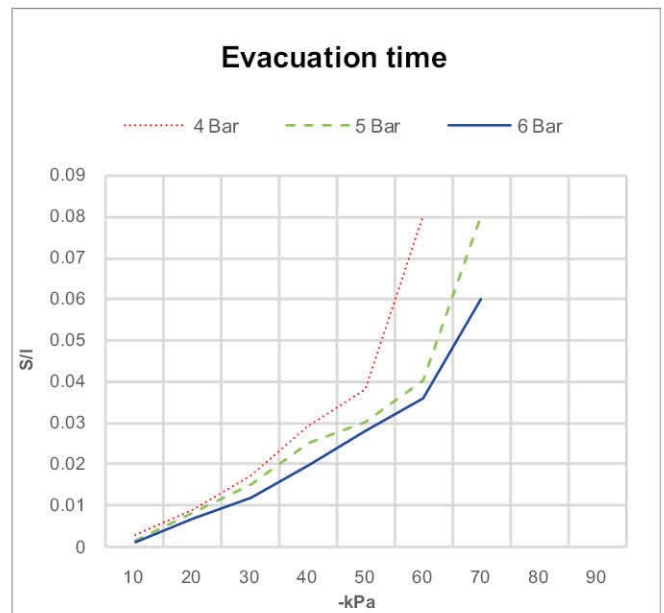

※ Time to evacuate a volume at different vacuum level

Performance data

MPM303x12

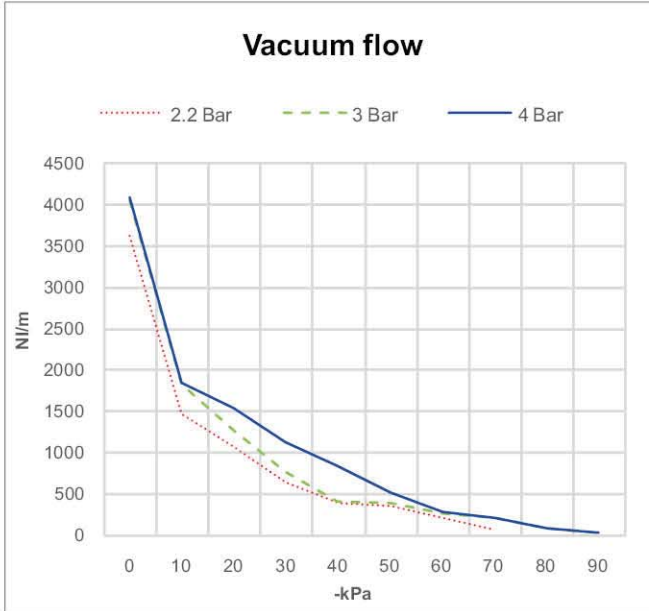

※ Vacuum flow at different vacuum level

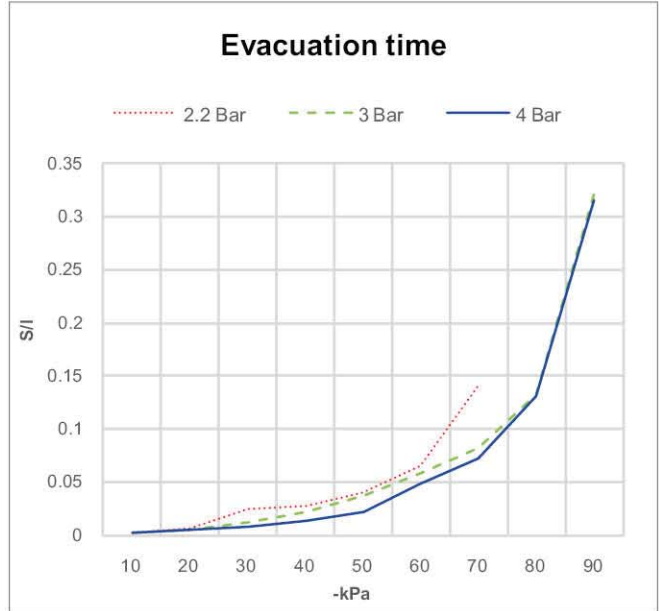

※ Time to evacuate a volume at different vacuum level

MPML303x12

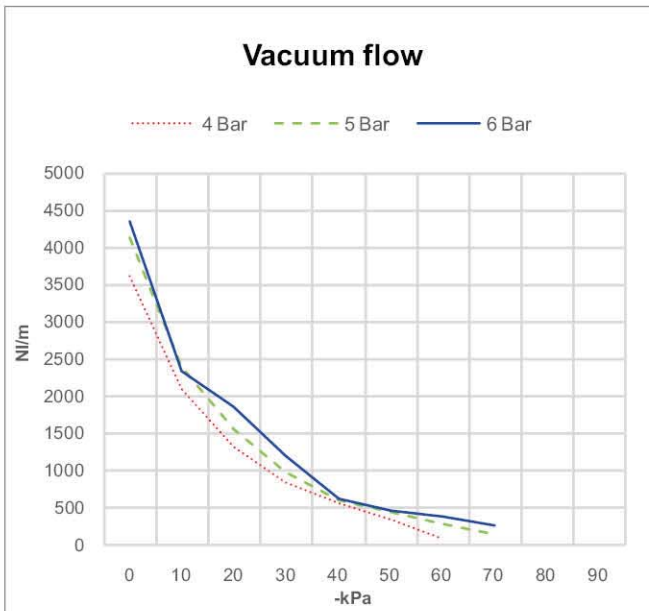

※ Vacuum flow at different vacuum level

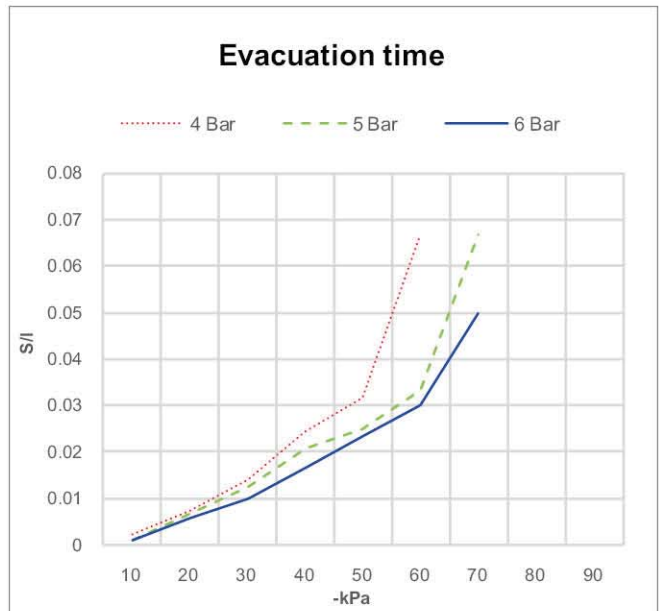

※ Time to evacuate a volume at different vacuum level

Performance data

MPM303x14

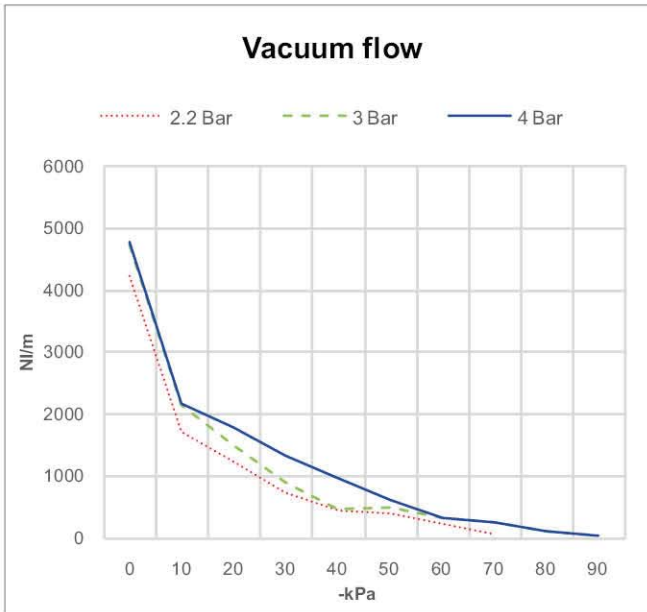

※ Vacuum flow at different vacuum level

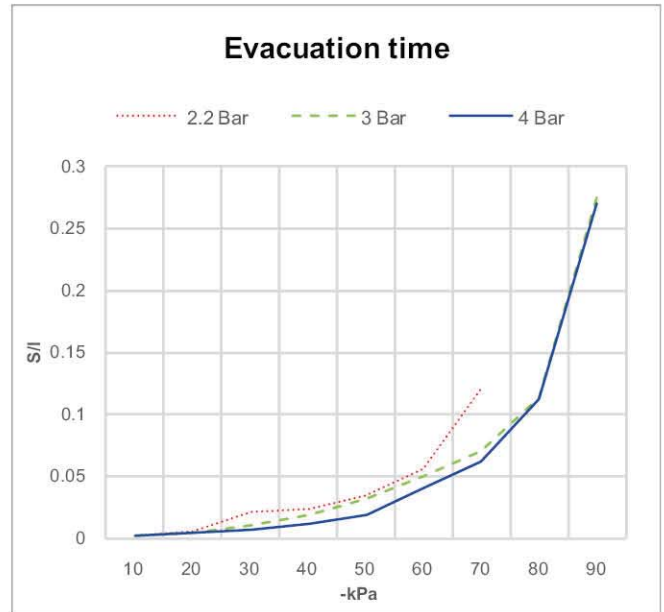

※ Time to evacuate a volume at different vacuum level

MPML303x14

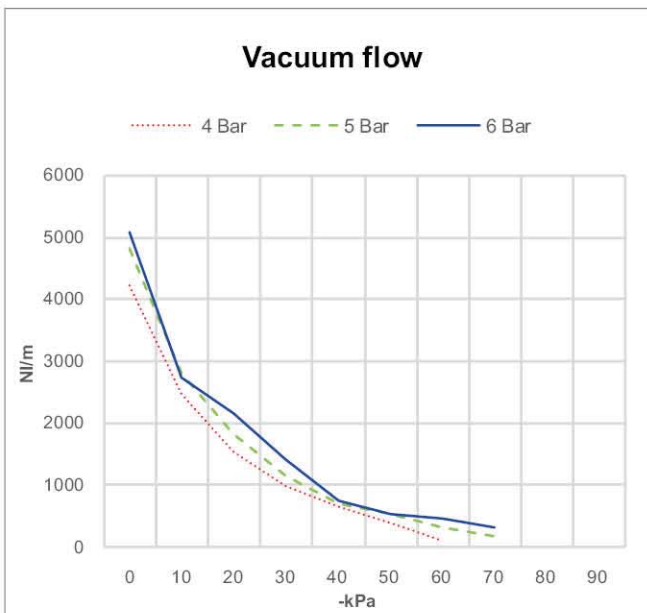

※ Vacuum flow at different vacuum level

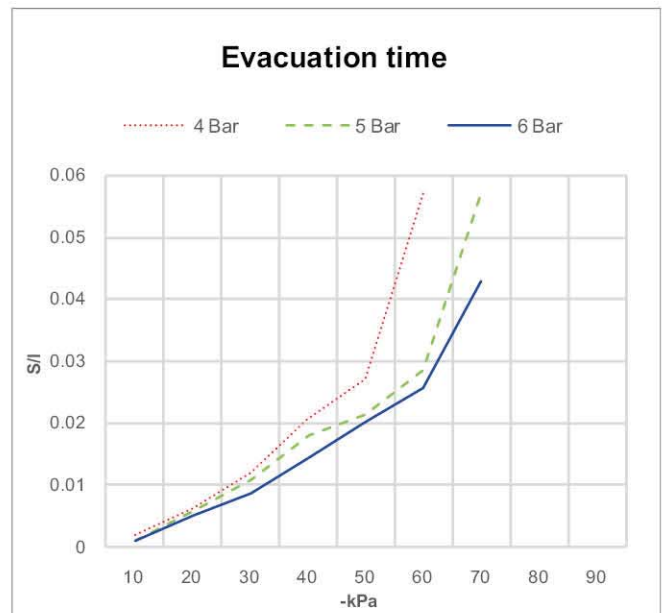

※ Time to evacuate a volume at different vacuum level

VACUUM PUMPS / Mega Premium pumps

Performance data

MPM303x16

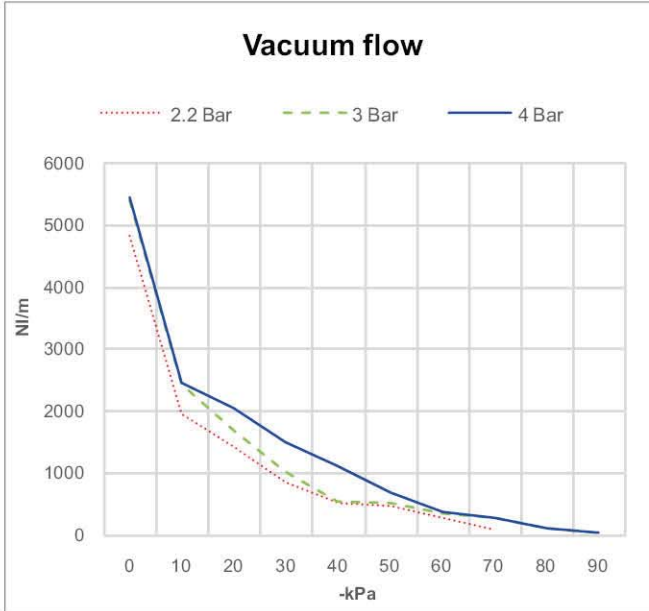

※ Vacuum flow at different vacuum level

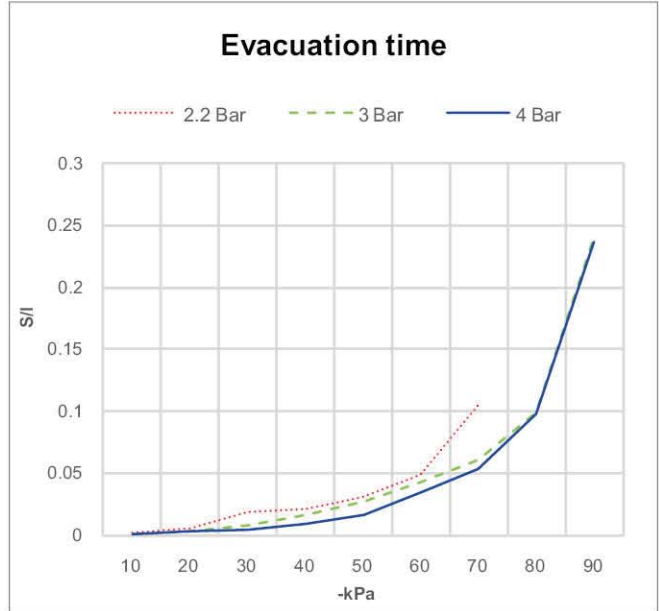

※ Time to evacuate a volume at different vacuum level

MPML303x16

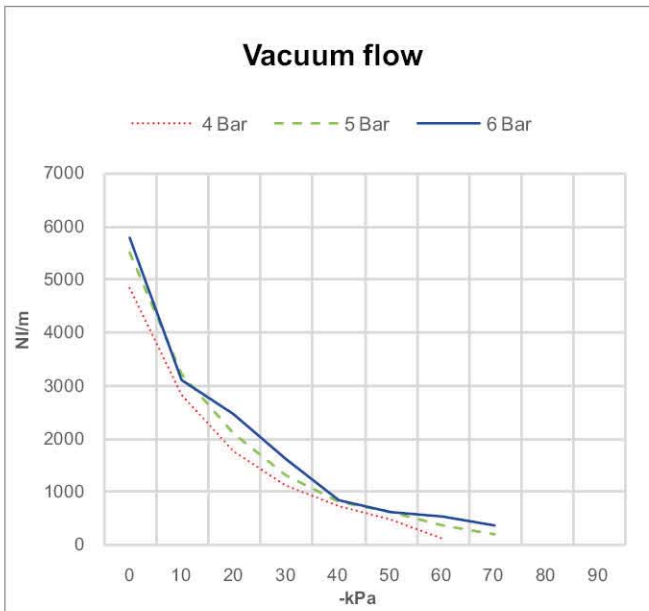

※ Vacuum flow at different vacuum level

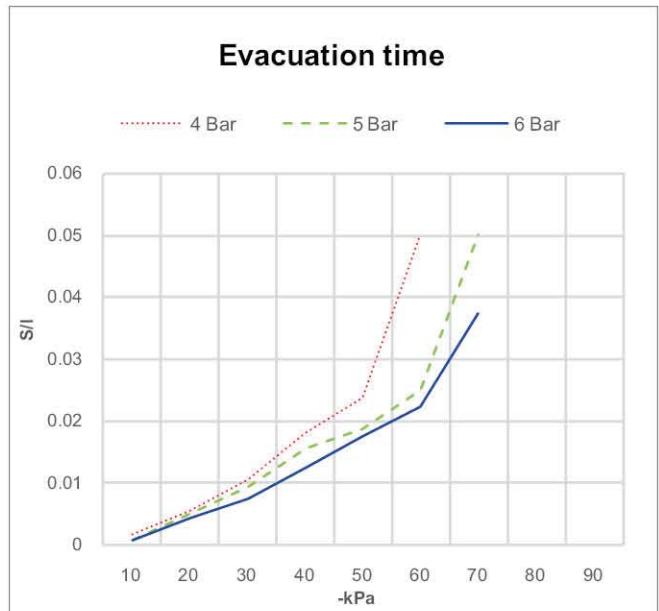

※ Time to evacuate a volume at different vacuum level

VACUUM PUMPS / Mega Premium pumps

I Build an Ordering No.

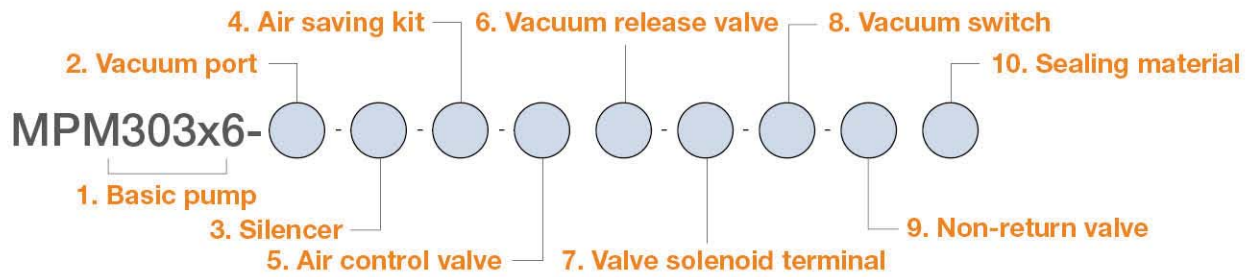

1. Basic pump	Description	Symbol
	MPM pump, 3-stage, 6-vacuum cartridge	MPM303x6
	MPM pump, 3-stage, 8-vacuum cartridge	MPM303x8
	MPM pump, 3-stage, 10-vacuum cartridge	MPM303x10
	MPM pump, 3-stage, 12-vacuum cartridge	MPM303x12
	MPM pump, 3-stage, 14-vacuum cartridge	MPM303x14
	MPM pump, 3-stage, 16-vacuum cartridge	MPM303x16
	MPM pump, 3-stage "L" cartridge, 6-vacuum cartridge	MPML303x6
	MPM pump, 3-stage "L" cartridge, 8-vacuum cartridge	MPML303x8
	MPM pump, 3-stage "L" cartridge, 10-vacuum cartridge	MPML303x10
	MPM pump, 3-stage "L" cartridge, 12-vacuum cartridge	MPML303x12
	MPM pump, 3-stage "L" cartridge, 14-vacuum cartridge	MPML303x14
	MPM pump, 3-stage "L" cartridge, 16-vacuum cartridge	MPML303x16
2. Vacuum port	Description	Symbol
	Vacuum port, G1-1/2"	02
	Vacuum port, G2"	03
	Vacuum port, G2-1/2"	04
3. Silencer	Description	Symbol
	No silencer	Blank
	Free flow silencer with G2-1/2"	S
4. Air saving kit	Description	Symbol
	No air saving kit	Blank
	Air saving kit without air control valve	AS
	Air saving kit integrated with air control valve	ASV
5. Air control valve	Description	Symbol
	No air control valve	Blank
	Air control valve, AC110V	A1
	Air control valve, AC220V	A2
	Air control valve, DC24V	A3
	Double air control valve, AC110V	D1
	Double air control valve, AC220V	D2
	Double air control valve, DC24V	D3
6. Vacuum release valve	Description	Symbol
	No vacuum release valve	Blank
	Vacuum release valve, AC110V	R1
	Vacuum release valve, AC220V	R2
	Vacuum release valve, DC24V	R3
7. Valve solenoid terminal	Description	Symbol
	Solenoid Terminal, DIN, No LW	DN
	Solenoid Terminal, DIN, Lamp, No LW	DL
	Solenoid Terminal, Conn, Lamp & 0.3m LW: <i>Only available with DC24V</i>	CL
	Solenoid Terminal, DIN, 2 in 1 BUS cable: <i>Not available with Double Solenoid Valve</i>	2B
	Solenoid Terminal, DIN, 3 in 1 BUS cable: <i>Not available with Double Solenoid Valve</i>	3B
	Solenoid Terminal, DIN, 4 in 1 BUS cable: <i>available with Double Solenoid Valve</i>	4B
	- 3B and 4B are available only with DC24V and S2 or S2P vacuum switch	

I Build an Ordering No.

8. Vacuum switch	Description	Symbol
	No vacuum switch	Blank
	Digital switch, No analog supply, M8-4pins, NPN	S2
	Digital switch, No analog supply, M8-4pins, PNP	S2P
	Digital switch, No analog supply, Grommet, NPN	SG2
	Digital switch, No analog supply, Grommet, PNP	SG2P
	Digital switch, Analog supply, Grommet, NPN	SG3
	Digital switch, Analog supply, Grommet, PNP	SG3P

9. Non-return valve	Description	Symbol
	No non-return valve	Blank
	Non-return valve: No need with Air saving kit	N

10. Sealing material	Description	Symbol
	NBR	Blank
	VITON	V
	EPDM	E

I Spare Parts – Basic pumps

Part No.	Description	Weight (g)
MPM303x6-02	MPM pump, 3-stage, 6-vacuum cartridge, G1-1/2" vacuum port	4,491
MPM303x8-02	MPM pump, 3-stage, 8-vacuum cartridge, G1-1/2" vacuum port	4,483
MPM303x10-02	MPM pump, 3-stage, 10-vacuum cartridge, G1-1/2" vacuum port	4,476
MPM303x12-02	MPM pump, 3-stage, 12-vacuum cartridge, G1-1/2" vacuum port	4,469
MPM303x14-02	MPM pump, 3-stage, 14-vacuum cartridge, G1-1/2" vacuum port	4,461
MPM303x16-02	MPM pump, 3-stage, 16-vacuum cartridge, G1-1/2" vacuum port	4,454
MPML303x6-02	MPM pump, 3-stage "L" cartridge, 6-vacuum cartridge, G1-1/2" vacuum port	4,487
MPML303x8-02	MPM pump, 3-stage "L" cartridge, 8-vacuum cartridge, G1-1/2" vacuum port	4,478
MPML303x10-02	MPM pump, 3-stage "L" cartridge, 10-vacuum cartridge, G1-1/2" vacuum port	4,469
MPML303x12-02	MPM pump, 3-stage "L" cartridge, 12-vacuum cartridge, G1-1/2" vacuum port	4,460
MPML303x14-02	MPM pump, 3-stage "L" cartridge, 14-vacuum cartridge, G1-1/2" vacuum port	4,451
MPML303x16-02	MPM pump, 3-stage "L" cartridge, 16-vacuum cartridge, G1-1/2" vacuum port	4,442
MPM303x6-03	MPM pump, 3-stage, 6-vacuum cartridge, G2" vacuum port	4,451
MPM303x8-03	MPM pump, 3-stage, 8-vacuum cartridge, G2" vacuum port	4,443
MPM303x10-03	MPM pump, 3-stage, 10-vacuum cartridge, G2" vacuum port	4,436
MPM303x12-03	MPM pump, 3-stage, 12-vacuum cartridge, G2" vacuum port	4,429
MPM303x14-03	MPM pump, 3-stage, 14-vacuum cartridge, G2" vacuum port	4,421
MPM303x16-03	MPM pump, 3-stage, 16-vacuum cartridge, G2" vacuum port	4,414
MPML303x6-03	MPM pump, 3-stage "L" cartridge, 6-vacuum cartridge, G2" vacuum port	4,447
MPML303x8-03	MPM pump, 3-stage "L" cartridge, 8-vacuum cartridge, G2" vacuum port	4,438
MPML303x10-03	MPM pump, 3-stage "L" cartridge, 10-vacuum cartridge, G2" vacuum port	4,428
MPML303x12-03	MPM pump, 3-stage "L" cartridge, 12-vacuum cartridge, G2" vacuum port	4,419
MPML303x14-03	MPM pump, 3-stage "L" cartridge, 14-vacuum cartridge, G2" vacuum port	4,409
MPML303x16-03	MPM pump, 3-stage "L" cartridge, 16-vacuum cartridge, G2" vacuum port	4,402
MPM303x6-04	MPM pump, 3-stage, 6-vacuum cartridge, G2-1/2" vacuum port	4,376
MPM303x8-04	MPM pump, 3-stage, 8-vacuum cartridge, G2-1/2" vacuum port	4,368
MPM303x10-04	MPM pump, 3-stage, 10-vacuum cartridge, G2-1/2" vacuum port	4,361
MPM303x12-04	MPM pump, 3-stage, 12-vacuum cartridge, G2-1/2" vacuum port	4,354
MPM303x14-04	MPM pump, 3-stage, 14-vacuum cartridge, G2-1/2" vacuum port	4,346
MPM303x16-04	MPM pump, 3-stage, 16-vacuum cartridge, G2-1/2" vacuum port	4,339
MPML303x6-04	MPM pump, 3-stage "L" cartridge, 6-vacuum cartridge, G2-1/2" vacuum port	4,373
MPML303x8-04	MPM pump, 3-stage "L" cartridge, 8-vacuum cartridge, G2-1/2" vacuum port	4,362
MPML303x10-04	MPM pump, 3-stage "L" cartridge, 10-vacuum cartridge, G2-1/2" vacuum port	4,353
MPML303x12-04	MPM pump, 3-stage "L" cartridge, 12-vacuum cartridge, G2-1/2" vacuum port	4,346
MPML303x14-04	MPM pump, 3-stage "L" cartridge, 14-vacuum cartridge, G2-1/2" vacuum port	4,336
MPML303x16-04	MPM pump, 3-stage "L" cartridge, 16-vacuum cartridge, G2-1/2" vacuum port	4,327

I Spare Parts – Silencer

Part No.	Description	Weight (g)
VTS-04	Free flow silencer with G2-1/2"	880