

SUCTION CUPS / Oval Universal

VOU15x45

Features and Strengths

Great performance for handling long objects with flat and curved surfaces

Examples of use

Semiconductor Chips, PCB boards, Electronic component
Solar cell, Small glass cases, Pipes



Recommended Lifting Force (Max.)

Model	Volume (cm ³)	Min. Curvature Radius R(mm)	Lifting Force (Kg) - Perpendicular		
			- 20 kPa	- 60 kPa	- 90 kPa
VOU15x45	1.584	11.00	1.06	2.88	4.22

※ The lifting force above does not include safety factor

Material Specifications

Material	Hardness Shore (°)	Color	Temperature (°C)
NBR	60	Black	-20~110
Silicone	55	Red	-70~200
White Silicone	55	Translucent White	-70~200
White Silicone (FDA)	55	Translucent White	-70~200
High temp. Silicone	50	Blue	-70~280
Conductive Silicone	70	Smoky Black	-45~90
Urethane	60	Dark Green	0~100

Material Resistance

Description	NBR	Silicone	White Silicone	High temp. Silicone	Conductive Silicone	Urethane
Wear Resistance	Excellent	Good	Good	Good	Good	Excellent
Oil	Excellent	Poor	Poor	Poor	Poor	Excellent
Weather / Ozone	Fair	Excellent	Excellent	Excellent	Excellent	Excellent
Alcohol	Good	Good	Good	Good	Good	Fair
Acid	Fair	Poor	Poor	Poor	Poor	Poor

Dimension

[Unit : mm]

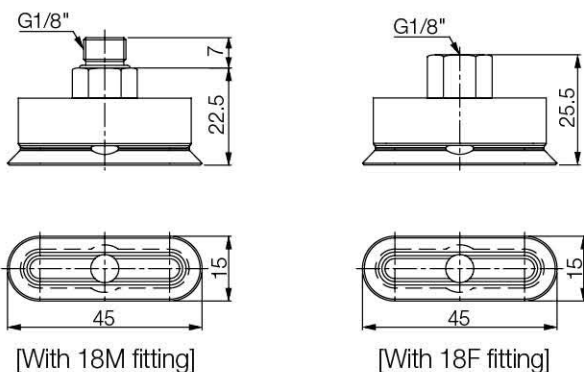

I Build an Ordering No.



1. Suction cup	Description	Symbol
	Oval-Universal suction cup, 15x45mm diameter, Nitrile (NBR)	VOU15x45-N
	Oval-Universal suction cup, 15x45mm diameter, Silicone	VOU15x45-S
	Oval-Universal suction cup, 15x45mm diameter, White silicone	VOU15x45-WS
	Oval-Universal suction cup, 15x45mm diameter, White silicone (FDA)	VOU15x45-WS (FDA)
	Oval-Universal suction cup, 15x45mm diameter, High temperature silicone	VOU15x45-HS
	Oval-Universal suction cup, 15x45mm diameter, Conductive silicone	VOU15x45-CS
	Oval-Universal suction cup, 15x45mm diameter, Urethane	VOU15x45-U

2. Fitting	Description	Symbol
	Fitting, G1/8 female	18F
	Fitting, G1/8 female, Mesh filter	M-18F
	Fitting, G1/8 male	18M
	Fitting, G1/8 male, Mesh filter	M-18M

I Spare Parts – Rubber Parts

Part No.	Description	Weight (g)	Color
VOU15x45-N	Oval-Universal suction cup, 15x45mm diameter, Nitrile (NBR)	5.82	Black
VOU15x45-S	Oval-Universal suction cup, 15x45mm diameter, Silicone	5.13	Red
VOU15x45-WS	Oval-Universal suction cup, 15x45mm diameter, White silicone	5.11	Translucent White
VOU15x45-WS (FDA)	Oval-Universal suction cup, 15x45mm diameter, White silicone (FDA)	5.11	Translucent White
VOU15x45-HS	Oval-Universal suction cup, 15x45mm diameter, High temperature silicone	5.26	Blue
VOU15x45-CS	Oval-Universal suction cup, 15x45mm diameter, Conductive silicone	5.76	Smoky Black
VOU15x45-U	Oval-Universal suction cup, 15x45mm diameter, Urethane	6.02	Dark Green

I Dimension

[Unit : mm]

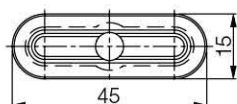
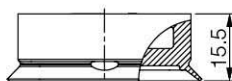

[Rubber part]

I Spare Parts – Fittings

Part No. (Code No.)	Fitting size	Description	Weight (g)
350 002 3121	18F	G1/8 female	10.32
350 002 3122	18F-F	G1/8 female, Mesh filter	10.46
350 002 3021	18M	G1/8 male	13.74
350 002 3022	18M-F	G1/8 male, Mesh filter	13.84